

DW1

**GENERAL WIRING WITH 2 ON-BOARD HIGH POWER ISOLATED RELAYS AND SEPARATE SUPPLY FOR CONTROLLER**

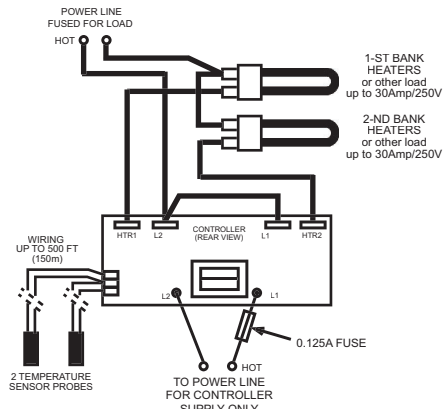

DW2

**WIRING FOR HIGH POWER HEATERS IN TWO BANKS AND SEPARATE SUPPLY FOR CONTROLLER**

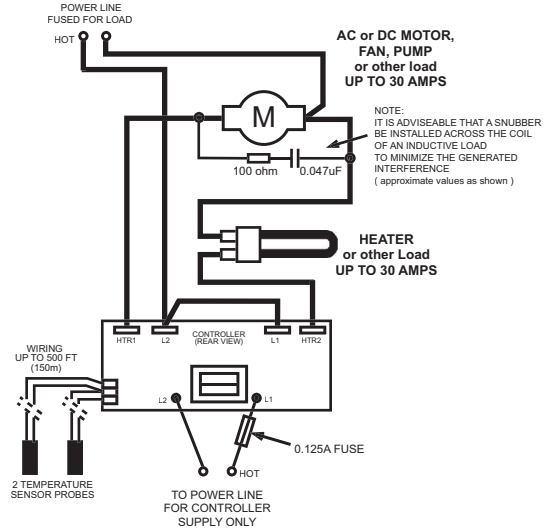

DW3

**WIRING FOR MIXED HIGH POWER LOADS AND SEPARATE SUPPLY FOR CONTROLLER**

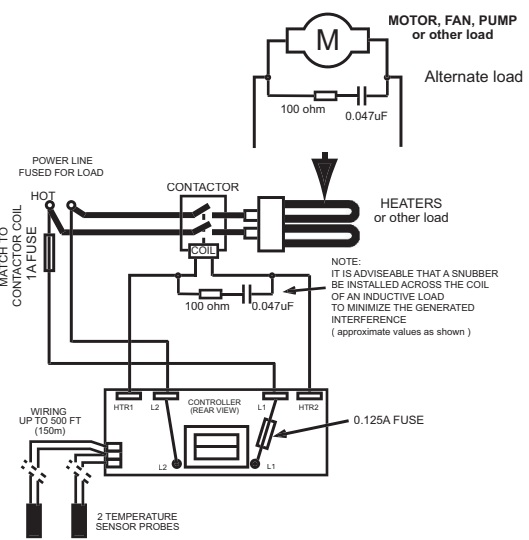

DW4

**WIRING FOR HIGH POWER LOADS USING EXTERNAL CONTACTOR**

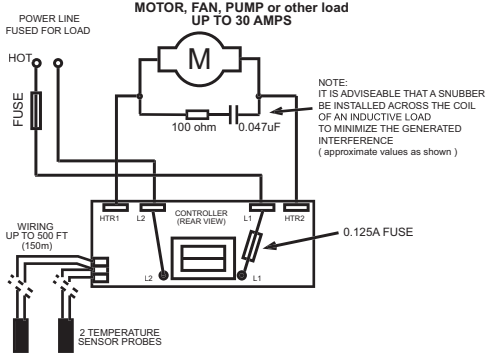

DW5

**WIRING FOR HIGH POWER AC MOTOR ( or other load ) USING 2 ON-BOARD HIGH POWER RELAYS**

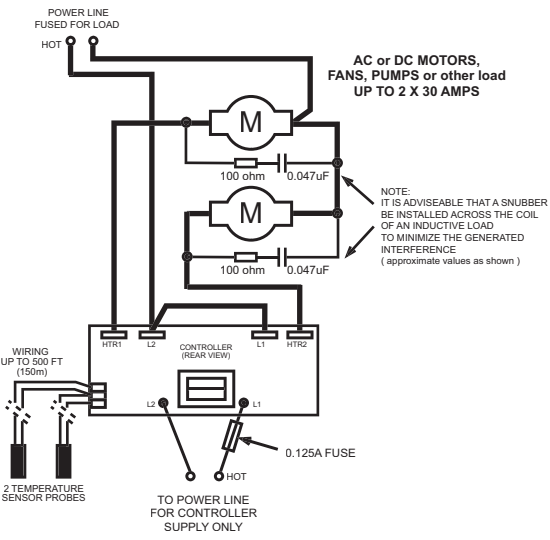

DW8

**WIRING FOR 2 HIGH POWER AC or DC MOTORS ( or other load ) AND SEPARATE SUPPLY FOR CONTROLLER**

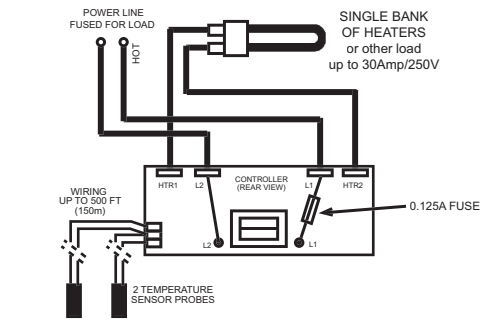

DW6

**SIMPLE WIRING FOR HEATERS ( or other load ) USING 2 ON-BOARD HIGH POWER RELAYS**

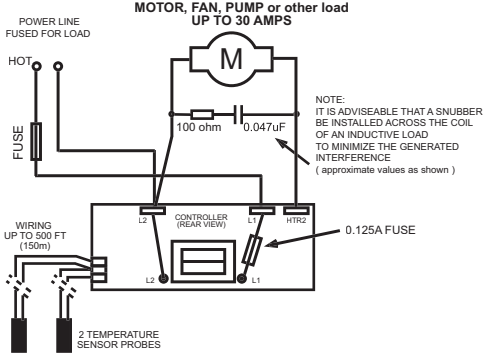

DW7

**SIMPLE WIRING FOR HIGH POWER AC MOTOR ( or other load ) USING ONLY 1 ON-BOARD HIGH POWER RELAY**

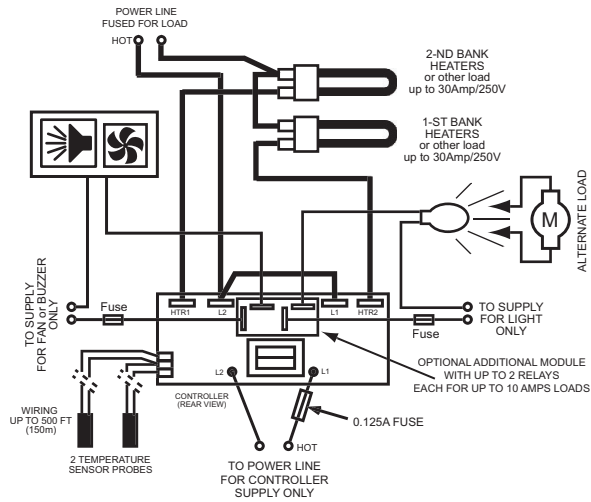

WIRING FOR 2 HIGH POWER LOADS USING OPTIONAL 2 ADDITIONAL RELAYS FOR LIGHT, PUMP, FAN ETC... AND WITH SEPARATE SUPPLY FOR LOADS AND CONTROLLER

DW9

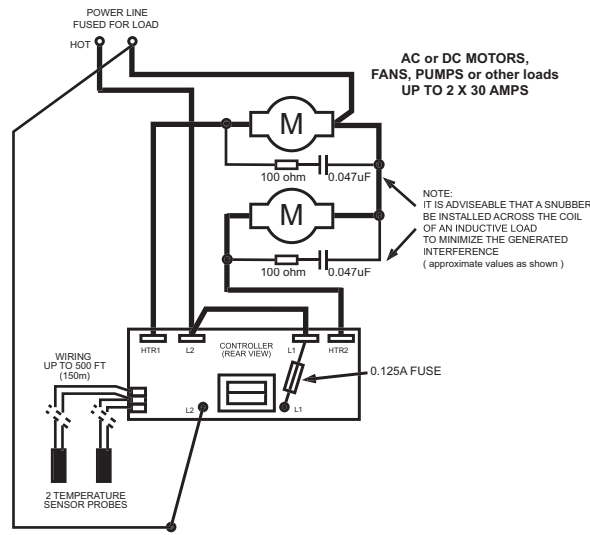

WIRING FOR 2 HIGH POWER AC OR DC MOTORS AND THE SAME SUPPLY FOR CONTROLLER

DW10

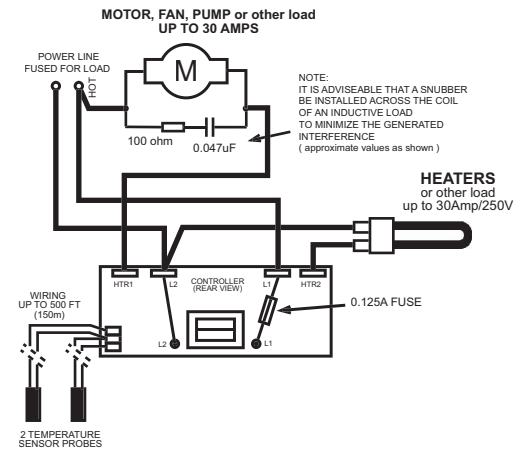

WIRING FOR COOLING MOTOR ( FAN or A/C ) AND HEATER ON THE SAME POWER LINE WITHOUT ADDITIONAL EXTERNAL RELAYS

DW11

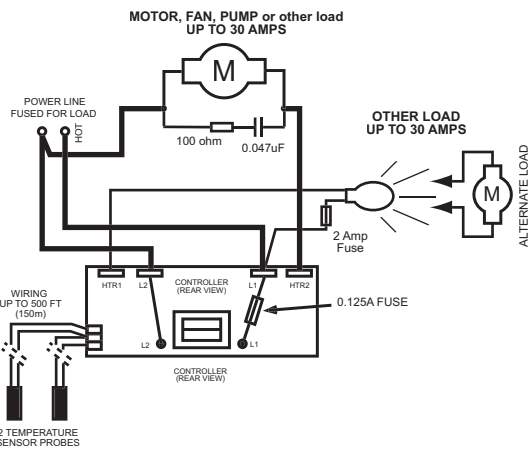

WIRING FOR MOTOR AND LIGHT OR OVERHEAT ( or Freeze ) PUMP ON THE SAME POWER LINE WITHOUT ADDITIONAL RELAYS

DW12

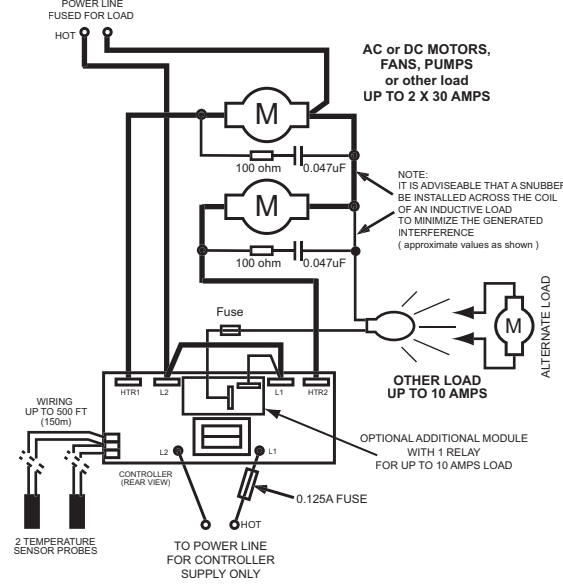

WIRING FOR 2 HIGH POWER MOTORS AND OPTIONAL ADDITIONAL RELAY FOR LIGHT, OVERHEAT OR FREEZE PROTECTION AND WITH SEPARATE SUPPLY FOR CONTROLLER

DW13

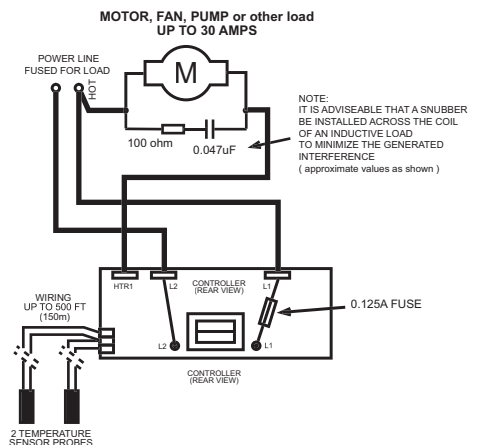

WIRING FOR MOTOR ( FAN or A/C ) or other load ON THE SAME POWER LINE AS CONTROLLER SUPPLY AND USING ONLY 1 ON-BOARD RELAY

DW14

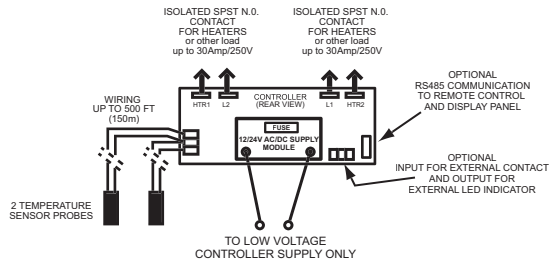

**GENERAL WIRING WITH 2 ON-BOARD HIGH POWER ISOLATED RELAYS AND LOW VOLTAGE SUPPLY FOR CONTROLLER**

DW15

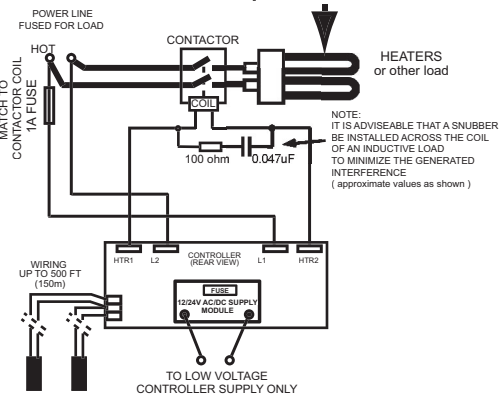
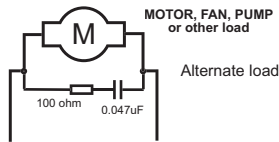

**WIRING FOR HIGH POWER LOADS USING EXTERNAL CONTACTOR AND WITH LOW VOLTAGE SUPPLY FOR CONTROLLER**

DW18

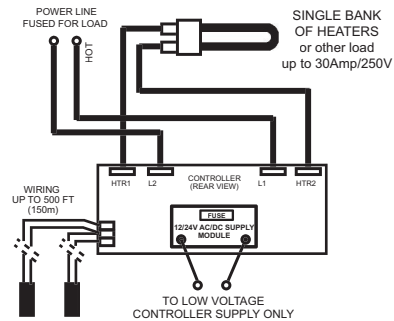

**SIMPLE WIRING FOR HEATERS ( or other load ) USING 2 ON-BOARD HIGH POWER RELAYS AND WITH LOW VOLTAGE SUPPLY FOR CONTROLLER**

DW20

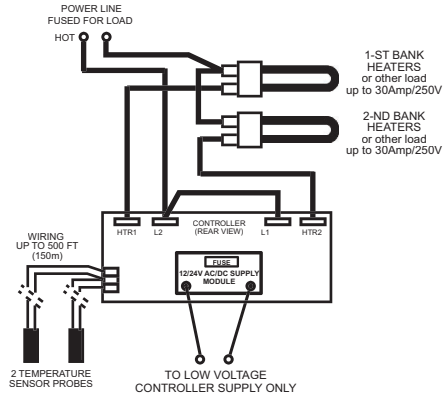

**WIRING FOR HIGH POWER HEATERS IN TWO BANKS AND LOW VOLTAGE SUPPLY FOR CONTROLLER**

DW16

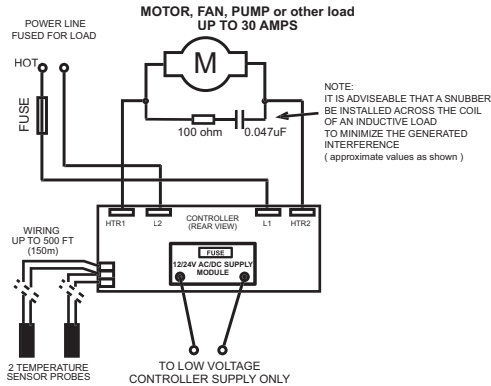

**WIRING FOR HIGH POWER AC MOTOR ( or other load ) USING 2 ON-BOARD HIGH POWER RELAYS AND WITH LOW VOLTAGE SUPPLY FOR CONTROLLER**

DW19

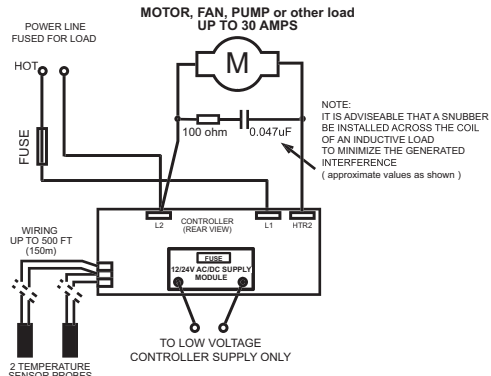

**SIMPLE WIRING FOR HIGH POWER AC MOTOR ( or other load ) USING ONLY 1 ON-BOARD HIGH POWER RELAY AND WITH LOW VOLTAGE SUPPLY FOR CONTROLLER**

DW21

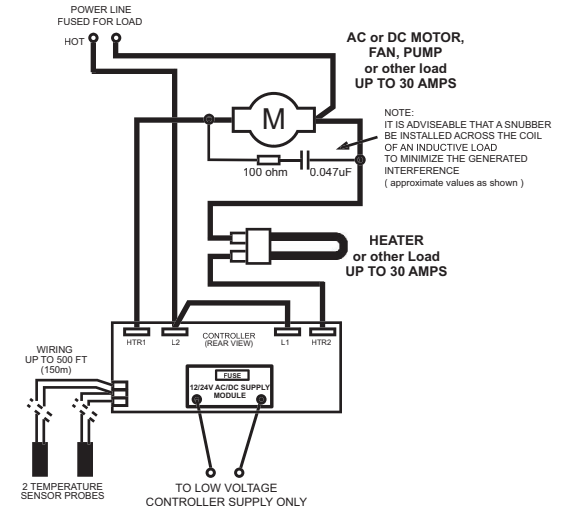

**WIRING FOR MIXED HIGH POWER LOADS AND WITH LOW VOLTAGE SUPPLY FOR CONTROLLER**

DW17

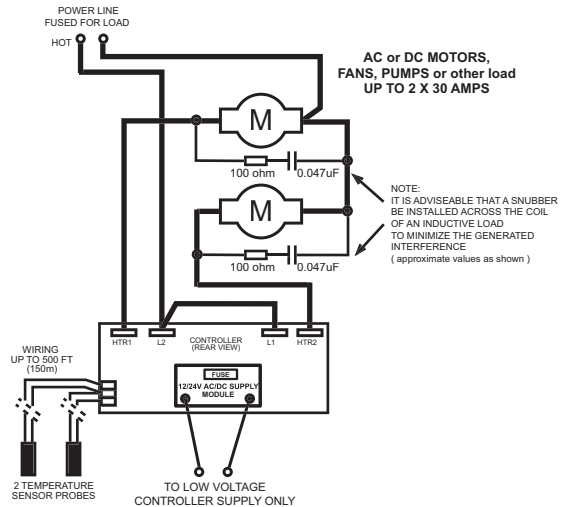

**WIRING FOR 2 HIGH POWER AC or DC MOTORS ( or other load ) AND WITH LOW VOLTAGE SUPPLY FOR CONTROLLER**

DW22