

DSDP-4PB Fully Programmable Difference Thermostat controller

This digital thermostat is designed for processes requiring programmable control of temperature difference between two locations.

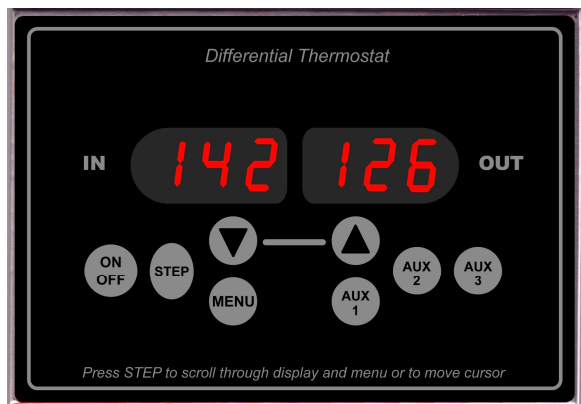

Front view of DSDP-4PB Differential Thermostat controller.

DSDP-4PB measures the absolute temperature as well as the temperature difference between two separate locations, using two external sensors. Depending upon the target temperature difference and some other settings preset by the user, two powerful on-board relays are driven as required to for the control application. Depending upon the programmed temperature limit values, the load can be protected against undesired events.

Up to two additional, optional relays can also be programmed to control other loads in some applications.

The 6 digits LED display indicates the current temperature readings, as well as the setpoint values for several control parameters and the status of the controlled relays. Up to 8 keys on the face plate are used to fully control the thermostat operation and to program the controller features.

Some keys also allow the user to drive the relays manually, which may be necessary during the system setup.

All data is stored in the internal memory.

DSDP-4PB is fully user programmable and customizable to satisfy many simple, as well as more sophisticated and demanding applications.

The programmable sequence of operation allows for control of a series of specific events dependant upon the status of several parameters occurring in real time.

Programmable control parameters :

The user can set the values of several limits for both temperature sensors :

- HOT = Overheat temperature Limit*
- Hi.L = High temperature Limit*
- Lo.L = Low temperature Limit*
- ICE = Freeze temperature Limit*
- d.Hi = Maximum difference setting*
- d.Lo = Minimum difference setting*

All of the above settings can be programmed by the user to any value within their operating range.

In most cases the order should be as follows: HOT > Hi.L > Lo.L > ICE .

The thermostat will however make sure that the Maximum Difference setting "d.Hi" value is always higher than the Minimum Difference "d.Lo" value.

The above temperature limits are used to prevent the controlled temperatures from traveling outside of the programmed values and / or to signal or take appropriate action when such events occur. The type of action taken is determined by the thermostat operation sequence, that can be modified by the user.

For ease of use, the temperature read on both sensors is designated and displayed as "IN" temperature and "OUT" temperature.

During operation the controller determines the status of the parameters by comparing the temperature readings on both sensors to the preset values, as follows:

- IN > HOT ?*
- IN > Hi.L ?*
- IN < Lo.L ?*
- IN < ICE ?*
- IN < OUT ?*
- Absolute Temp Difference > d.Hi ?*
- Absolute Temp Difference <= d.Lo ?*
- Absolute Temp Difference > { (d.Hi + d.Lo) / 2 } ? (this is a "center differential" d.Cn calculated automatically)*
- OUT > HOT ?*
- OUT > Hi.L ?*
- OUT < Lo.L ?*
- OUT < ICE ?*

Based on such comparisons and on the settings programmed by the user, the controller then drives the output relays, as required for the process.

Face keypad operation :

The ON/OFF key operates as the thermostat ON/OFF switch.

When the thermostat is ON, it will switch the on-board relays as programmed for the process.

When the thermostat is OFF, it will only indicate the current temperatures readings and the relays status. However, at this state the user can manually control the state of the relays by operating the AUX1, AUX2 and AUX3 keys. Note, that the manual control of the relays is reset automatically when the thermostat is switched ON.



DSDP-4PB Mounting kit and accessories included with each controller set.

The thermostat will re-start automatically when the supply power is interrupted and subsequently restored, if it was ON before the supply power interruption. This feature can be altered by the user, if needed.

By pressing the STEP key, the display can be scrolled to show some basic thermostat setpoints

To adjust and/or see more settings, press the MENU key once and then press the STEP key repeatedly. The display will scroll through ALL user settings and at that point the settings can also be modified by pressing the UP or DOWN arrow keys.

To switch between the F and C units, press the UP and DOWN arrow keys simultaneously.

Relays operation :

DSDP-4PB has two, three or four on-board relays, depending upon the model.

Two main relays Rel 1 and Rel 2 have Normally Open, SPST contacts rated up to 30Amp/250V max. each.

Either one or both can be used to control one or two separate loads. The relays contacts can be wired up as common or as separated (isolated) from the thermostat supply and each other. See the example wiring diagrams for detail.

The optional, additional relays (Rel 3 and Rel 4) can be used for additional functions, for instance when the Freeze (ICE) and / or the Overheat (HOT) temperature limits are exceeded. These optional relays are usually rated at 10Amp/250V max. and are Normally Open, SPST type.

The user, if needed, can program the controller to swap the action between the REL 3 and REL 4 as well as swap REL 4 and REL 2.

It is also possible to make the REL 1 copy the state of REL 2 or REL 2 copy the state of REL 1.

NOTE: The controller has an "Anti-Cycle" function built in, that prevents the relays from switching too frequently when the temperature is near the switching point. The anti-cycle delay can be modified by the user as well.

LED display :

DSDP-4PB has a bright 6 digits LED display. The display color can be ordered as Red, Green or Blue.

When the controller is OFF, the display will show "OFF" alternating with the status of the relays.

When the controller is ON, the display will alternate between the text "On", the current temperature readings and the status of the relays.

To see the temperature differentials as well, press the STEP key repeatedly.

In order to see all settings, press the MENU key and use the STEP key to scroll through all setpoints. At his point the settings can also be altered.

Temperature Sensor PROBES:

Each controller kit includes 2 external temperature probes. A number of standard temperature probes is available, depending upon the application. Most probes are small in size. The most popular is a small, tubular sensor appx. 25 mm long and 5 mm diameter (1"lg. x 0.2" dia.). The probes have two wires attached at one end and are sealed on the other end.

The sensors wiring can be extended with *any type of a 2-conductor cable* up to appx. 500 ft. (150 m).

Standard probes have 1% accuracy and the operating ranges vary from -40F to +255F (-40C to +124C) up to -60F to +960F (-50C to +515C), with special thermistor or RTD probes. The probes are enclosed in a non-corrosive housing that may be Stainless Steel, chrome plated, black anodized, brass or plastic with two PVC, Teflon or silicone jacketed leads, sealed with epoxy resin to prevent the moisture penetration. In some cases, in order to further improve the moisture resistance or even provide immersability in a liquid, the probes' housing may need to be additionally protected with silicone sealant, heat shrink or installed in a thermowell.

NA7100KB4100BLK



NA7100KB4100CHR



NA7100KB4100RDT



NA7100KB4100SQT



NA7100KB4100DPD



NA7100KB4100SHD



PT1000TC38550MM



NA7100KB4100PIPTR



Variety of available temperature sensor probes.

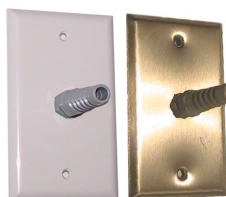

Optional sensor probe plates (plastic model PPP-4 or metal model PPS-4)



Optional sensor probe PROTECTIVE shield Model PG-5



NA7100KB4100SSFLG

Temperature sensor probe with Flange

Electrical:

DSDP-4PB thermostat models are available for 120Vac, 208-240Vac, 12Vac, 24Vac, 50/60Hz as well as 12V or 24V DC. The supply voltage must be specified when ordering. The controller electronics is protected by one on-board 20 mm, removable fuse, that can be serviced in the field. Standard models have two on-board relays, each SPST, Normally Open.

The two high power relays can switch loads up to 30Amp, 250Vac max. each (40 Amp is optional).

Two optional, additional SPST, N.O. relays can switch loads up to 10Amp, 250Vac max. each .

NOTE, that the contacts of all relays can be completely isolated from the controller supply and from each other, depending upon the chosen method of wiring.

Options:

Many Temperature and Differential ranges, as well as various types of relays and wiring methods, can be supplied upon the customer request.

A unique feature of the DSDP-4PB controller is that it is fully programmable and customizable by the user as well. All setpoints, parameters and limits can be altered using a programming procedure via the face plate keys.

Using XLS spread sheet tables, the user can design a control process involving up to 32 different states of operation, as necessary for a sequence of events for a particular application.

Models with almost any desired configuration can be configured or requested when ordering.

Installation:

DSDP-4PB controllers are normally shipped without enclosures (optional) and are designed to fit in a standard 3-gang electrical wiring box or in a panel. The plastic overlay can be installed on either a customer supplied face plate or the standard Mounting Plate included in the kit. All mounting hardware, screws and wiring connectors are included. When correctly installed, there are no screws visible on the face plate.

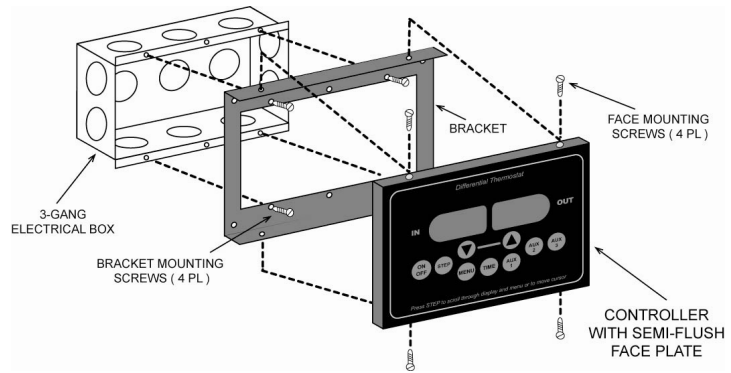

Installation example: SEMI-FLUSH in 3-GANG electrical wiring box.

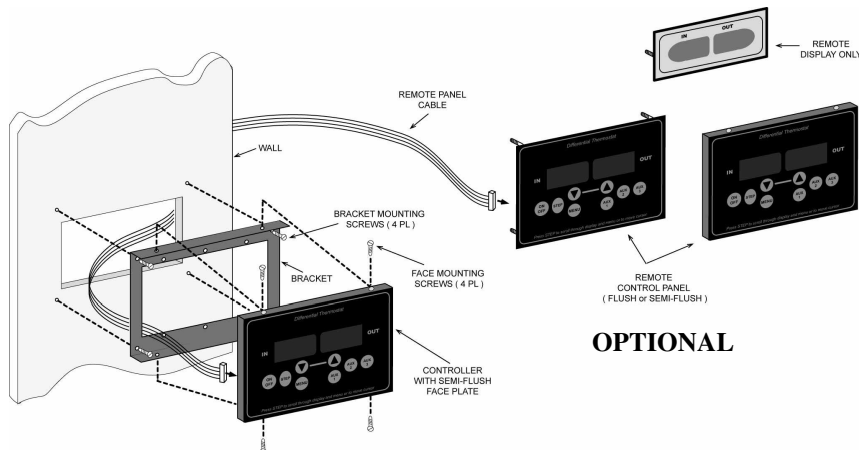

OPTIONAL

Installation example: SEMI-FLUSH in a wall or panel With optional REMOTE CONTROL / DISPLAY PANEL

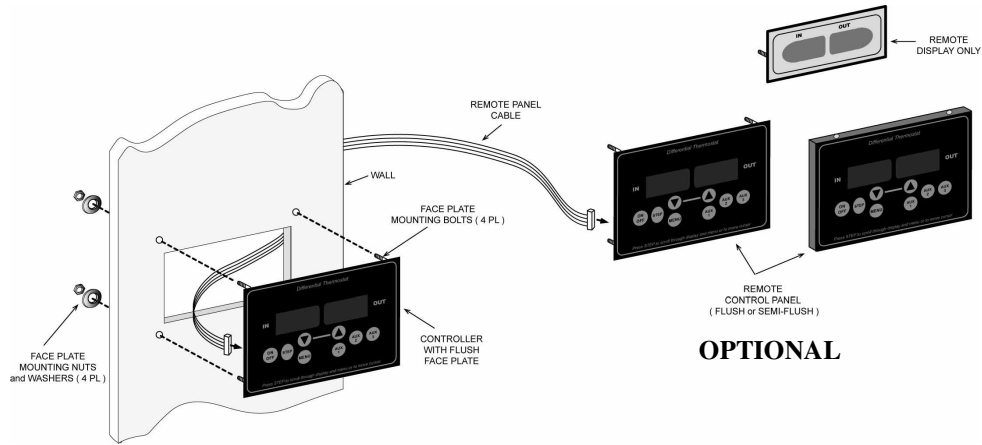

**Installation example: FLUSH in a wall or panel
With optional REMOTE CONTROL / DISPLAY PANEL**

Wiring:

Depending upon a particular application, there are many practical ways of wiring up the DSDP-4PB controller.

The controlled load can be heaters, chillers, contactors, motors, pumps, solenoids, fans, Resistive or inductive loads high or lower power demands. Following are a few possible examples:

etc...

with

only

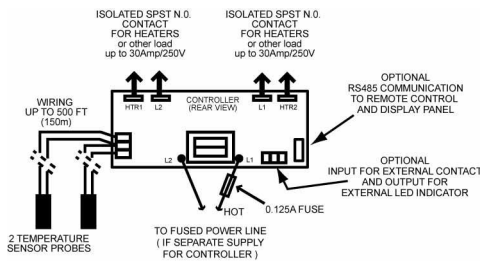

Basic wiring using separate supply for controller.

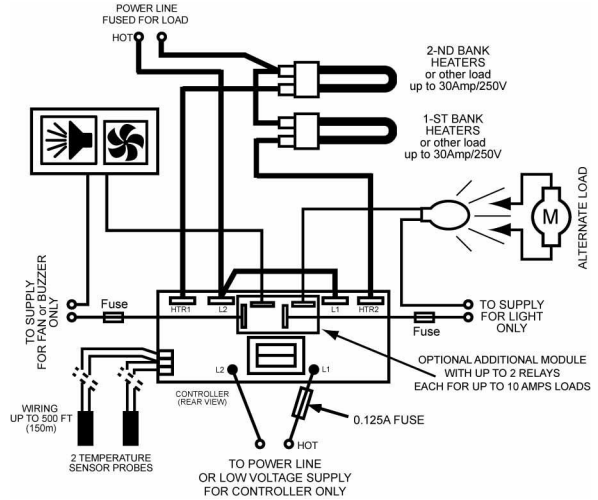

Wiring with supply for controller and for the loads separated from each other. Model with 4 relays shown.

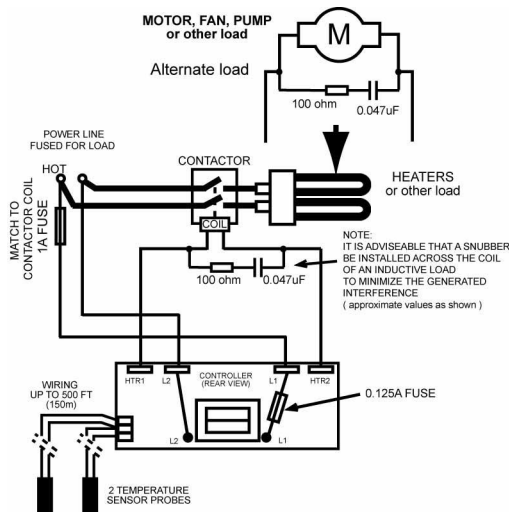

Wiring using external contactor to boost the load

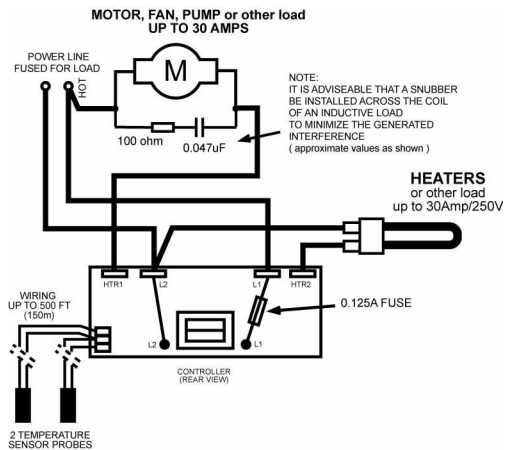

Simple wiring for fan / pump and heating

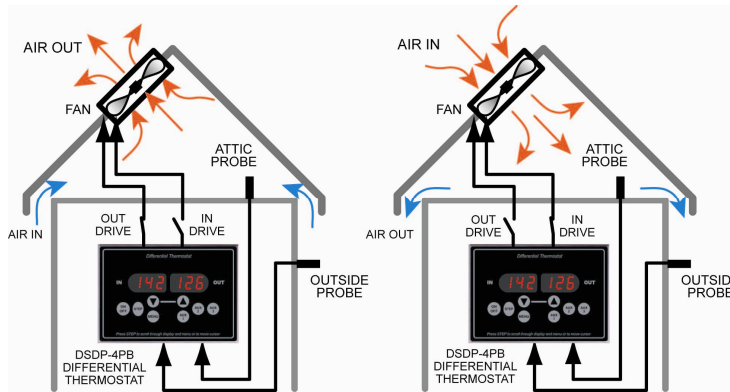

DSDP-4PB as ventilation controller

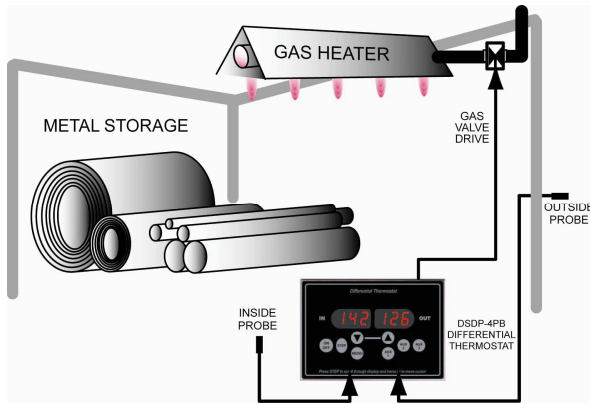

Metal rust prevention by holding the inside warmer than outside

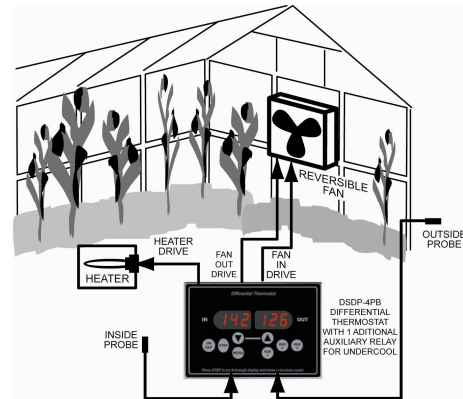

DSDP-4PB as energy saving greenhouse climate controller

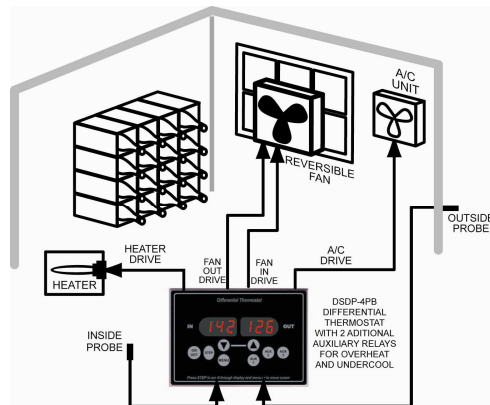

DSDP-4PB as energy saving wine cellar climate controller

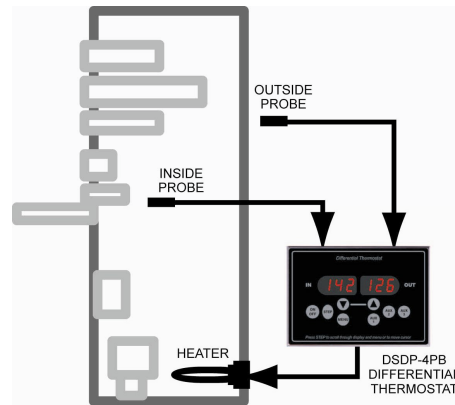

Switchgear humidity condensation prevention by holding the inside warmer than outside

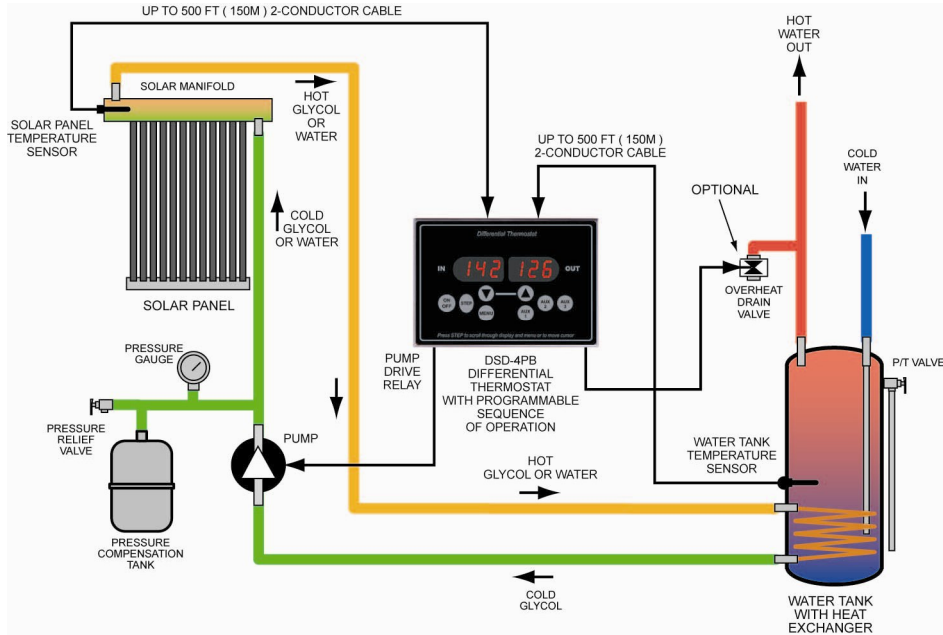

Simple solar water heating system

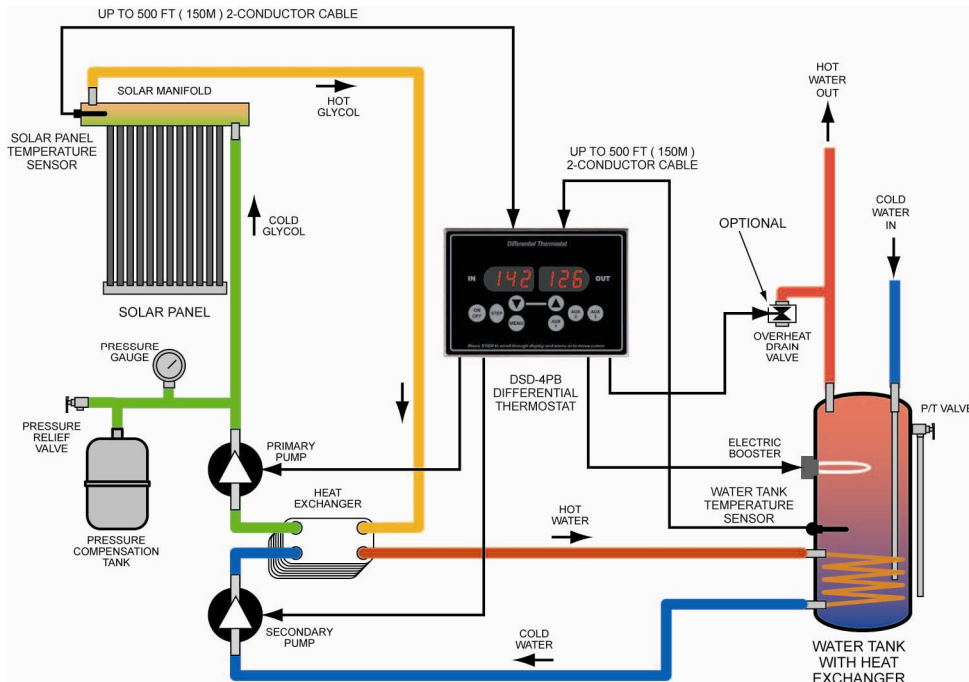

Solar water heating system with two pumps, boost heater, valve and heat exchanger

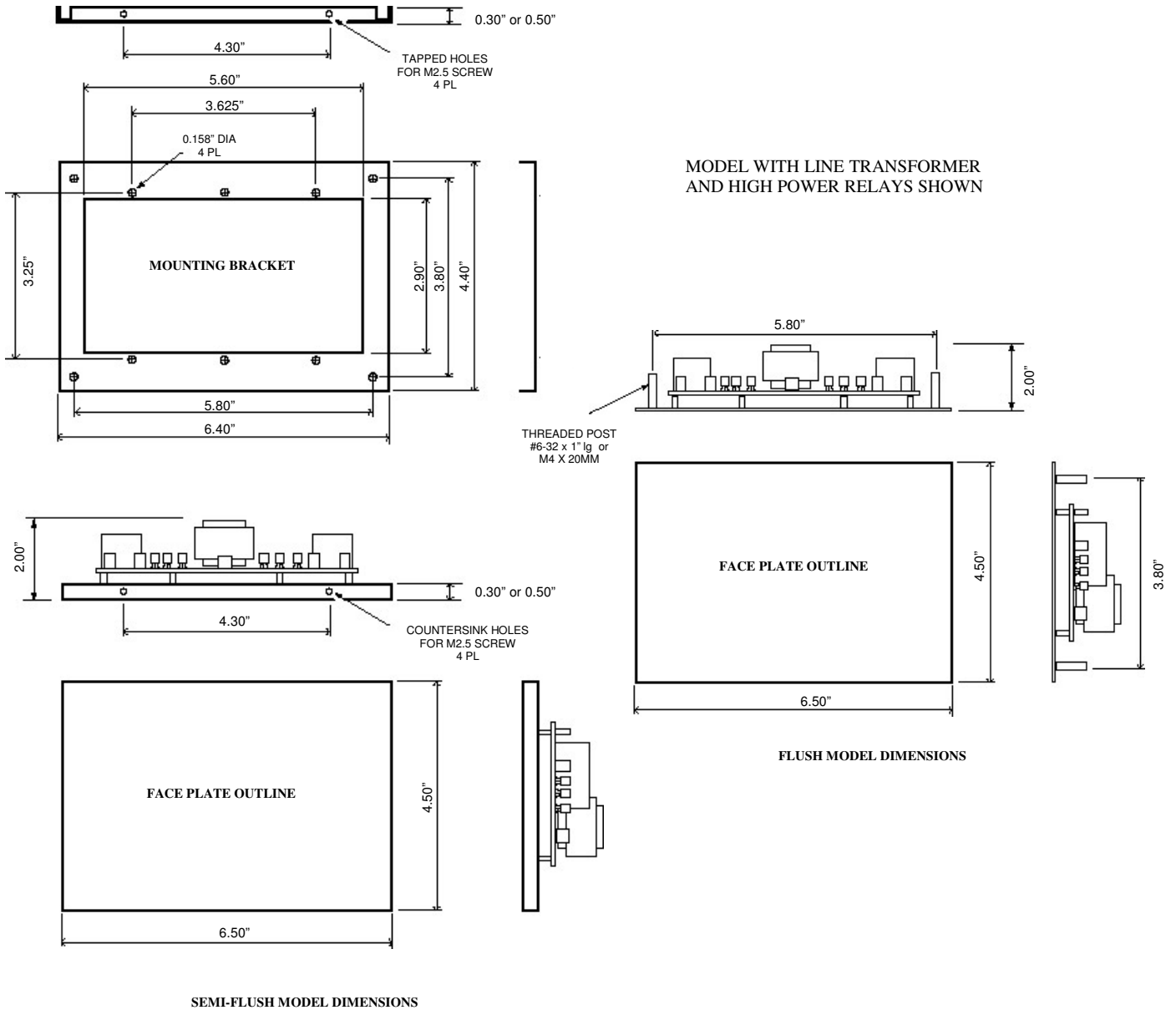

OPERATING INSTRUCTIONS: (Example for a simple Solar Heating applications with two relays only)

*NOTE, that the controller operation, as described below, is determined by the programming of the "Operating Sequence".
The programming can be done or modified by the user, or the controller can be ordered as pre-programmed .*

HOW TO START:

To activate the controller press the ON/OFF key.

The display alternates between "On" , the temperature readings and the status of the relays.

To see the current MINimum (d.Lo) and MAXimum (d.Hi) presets, press the STEP key repeatedly.

TEMPERATURE SETTINGS ADJUSTMENT:

Press the MENU key and then press the STEP key repeatedly until d.Lo or d.Hi differential preset values come on display and begin flashing. Then use the UP or DOWN arrow keys to set the required values.

Similarly, to alter other temperature setpoints and limits values, follow the above procedure.

After the setting is finished, the display will return to normal operation automatically.

To toggle the temperature units between Celsius and Fahrenheit, press both, the UP and DOWN arrow keys simultaneously.

All settings are saved in internal memory.

DIFFERENTIAL CONTROL OPERATION (simplified description):

Relay 1 (pump) is switched ON when the temperature difference between the IN and OUT sensors exceeds the preset MAXimum differential value (d.Hi) and if the absolute temperatures are within acceptable ranges preset by the user.

Relay 1 is switched OFF when the difference becomes lower than the preset MINimum differential value (d.Lo).

When the temperature on the tank sensor exceeds the preset HOT (overheat) temperature value, Relay 2 (valve) is switched ON until the temperature becomes lower than the preset Hi.L (high limit) value, at which point Relay 2 will be switched OFF.

When the solar panel sensor temperature is below the preset Lo.L (low limit) value, Relay 1 is switched OFF, even if the temperature differential is higher than the preset MAXimum differential value.

When the solar panel sensor temperature is below the preset ICE (freeze) value, Relay 1 is switched ON in order to circulate the fluid to prevent it from freezing, even if the temperature differential is lower than the preset MINimum differential value.

Note, that the above operation can be changed at any time by re-programming the operating sequences.

IDLE/MONITORING OPERATION:

The display alternates between "OFF" , the temperature readings and the status of the relays.

AUTOMATIC STOP and ERROR detection:

The controller stops automatically when a malfunction is detected or the controller operating temperature limits are exceeded. At that point the display will show the cause of the error by scrolling a message on the display.

CAUTION: All installation and adjustments of the controller options **MUST** be done **ONLY** when **ALL POWER** to the load and the controller is disconnected.

TROUBLESHOOTING:

The sensors wiring and internal parts are continually checked for proper operation. If a malfunction is detected, the controller will automatically switch OFF the loads. At the same time the display will show a scrolling message about the detected error.

The controller can not be reactivated until all causes of the malfunction are fixed.

Following is an example of specifications for a selected model. Note, that all temperature ranges, electrical, as well as mechanical specifications can be modified by the customer.

Example model: **DSDP-4PB-2HP-120-FN40P255-2NA7100KB4100CHR**
(preconfigured for simple Solar Heating applications)

<i>SPECIFICATIONS:</i>	<i>VALUE</i>	<i>NOTES, COMMENTS</i>
<i>Electrical:</i>		
Supply Voltage:	105-130Vac, 50/60 Hz	208-250Vac, 50/60Hz or 12/24V AC/DC
Supply Current (controller):	50 mA RMS max. (at 120Vac)	Can be lower for different voltages, relays and display brightness or color
High Power Relays:		
Max. Switched Load:	2 x 30 Amp, 250Vac Max.	Can be different for other relay models
Optional Low Power Relays:		
Max. Switched Load:	2 x 10 Amp, 250Vac Max.	Can be different for other relay models
Switching Reliability:	10,000,000 electrical 10,000,000 mechanical	For AC load
Switching Anti-Cycle:	10 sec. On ON action	Can be preset to other value on request
Oper. Ambient temperature:	-4 to +158F (-20 to +70C) (standard)	-20 to +90C extended with high temp LEDs
Control temperature range:	-40 to +255F (-40 to +124C) (standard)	Can be extended up to -60F to +960F
Differential Preset Range:	0 to 99F (55C)	Other ranges available
Temp. reading accuracy:	+/- 1%	Over the operating range
Hysteresis:	(+1F, -0F (+0.5C, -0C)	Can be set to any value on request
Temp. Display resolution F:	1 F	Other available on request
Temp. Display resolution C:	1 C	Other available on request
Probes Temperature Range:	-40 to +255F (-40 to +124C) (standard)	Extended temp. avail. on custom orders
Probes wiring distance:	500 Ft (150 m) max.	Can be extended on special order
Probe dimensions:	1" x 0.2" dia (25mm lg. x 5mm dia.)	Chrome plated or other probes per request
LED Display:	6 digits, 0.56" high	
Display color:	RED, GREEN or BLUE	Different colors upon request
<i>Mechanical:</i>		
Face plate:	Metal, baked powder paint	Flush or Semi-Flush mounted face plate
Face plate dimensions:	6.5" x 4.5" (165mm x 115mm)	
Mounting Bracket:	Metal, baked powder paint	Semi-Flush , depending upon the model
Mounting bracket dimensions:	6.4" x 4.4" (162mm x 112mm)	For Semi-Flush models
Controller dimensions::	5.35" x 2.76" x 1.89" (LxWxD) (136mm x 70mm x 48mm)	Models with transformer
Overall weight:	350 gm	Models with transformer
Shipping Packaging:	Carton with bubble padding	
Accessories pack:	Crimp Spade connector: 4 pcs, Mounting screws: 4 pcs (if needed) Face plate, Bracket and Lexan decal: 1 pc each	